

Carbon Monoxide Transmitter (RS485 output) Instruction Manual

Thanks for choosing our product! Please read carefully and follow this instruction before using!

Introductions

CO is a colorless, odorless and tasteless gas. It can bond to our Hb as COHb and circuit in human body. When we breathe air containing CO, it is absorbed through the bloodstream where it displaces oxygen and bonds with the hemoglobin in your blood. CO has a greater affinity to hemoglobin than oxygen; CO bonds to hemoglobin about 200-300 times better than oxygen. Without oxygen, vital organs, your heart and brain become deprived and will begin to deteriorate. To compensate, your heart rate increases, breathing may become difficult and in the most serious circumstances cardiac trauma, brain damage, coma and even death will result.

We are actually in a circumstance full of uncertain risk. AVC-110 series CO transmitter can be applied in kitchen, garage, basement parking, boiler room and etc., to provide a safe way and to secure our lives against any CO threat.

Wiring

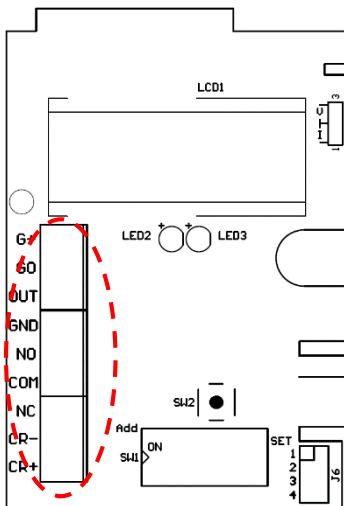

1	G+	DC 12 ~ 36V AC 24V (50/60Hz)
2	G0	System GND
3	OUT	N/A
4	GND	N/A
5	NO	Normally opened
6	COM	Com
7	NC	Normally closed
8	CR-	RS485-
9	CR+	RS485+

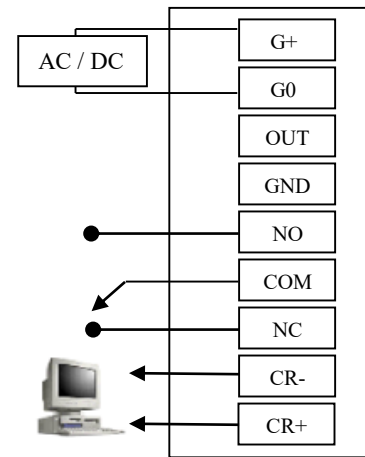

【Figure 1】

CO Measuring range setting

Define CO measuring range with the jumper in SET2 & SET3

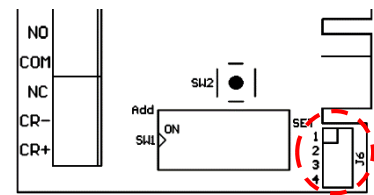

	SET2	SET3
0~100 ppm(default)	● ●	● ●
0~250 ppm	● ●	● ●
0~500 ppm	● ●	● ●



Relay output (CO alarm setting point)

- The default alarm relay output is at 50ppm with hysteresis of 10ppm.
- When the CO concentration reaches the alarm setting point, LED indicator will be switched on.

RS485 Setting

1 Device ID: Setup device ID with dip switch; ON  :1 ; OFF  :0

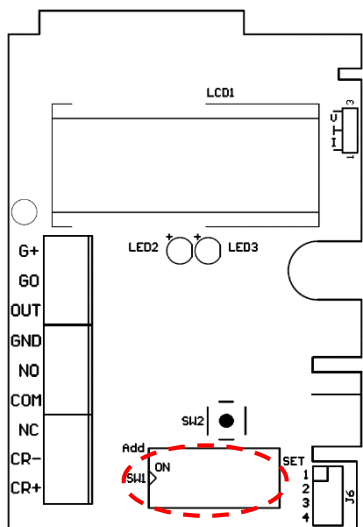

Device ID (ON : 1,OFF : 0)							
1	0000 0001		127	0111 1111			
2	0000 0010		128	1000 0000			
⋮		⋮	⋮		⋮		
64	0100 0000		246	1111 0110			
65	0100 0001		247	1111 0111			

2 Protocol :

2.1 Baud Rate = 9600; Word Length = 8; Parity = none; Stop Bits = 1

2.2 Checksum is in CRC-16(Modbus).

Data Reading Type

Device ID	Function	Address (High byte)	Address (Low byte)	Data Length (High byte)	Data Length (Low byte)	Checksum (High byte)	Checksum (Low byte)
By setting	0x03	0x00	0x00	0x00	0x01	0xXX	0xXX

Responding Data Type

Device ID	Function	Data Byte	Data (High byte)	Data (Low byte)	Checksum (High byte)	Checksum (Low byte)
By setting	0x03	0x02	0x00	0x32	0xXX	0xXX

****Remark :** The CO reading is expressed in hexadecimal. Convert 0x0032 to DEC, it will be 50ppm. ◦

3 Calibration :

To calibrate 50ppm to 40ppm, convert the calibration value to 0xFFFF6 (hexadecimal), the corrected values would be (40 - 50) = -10 ppm.

Device ID	Function	Address (High byte)	Address (Low byte)	Data (High byte)	Data (Low byte)	Checksum (High byte)	Checksum (Low byte)
By setting	0x06	0x00	0x01	0xFF	0xF6	0xXX	0xXX

With command “0x0000” can reset setting to default value.

Device ID	Function	Address (High byte)	Address (Low byte)	Data (High byte)	Data (Low byte)	Checksum (High byte)	Checksum (Low byte)
By setting	0x06	0x00	0x01	0x00	0x00	0xXX	0xXX

****Remark :** The calibration range is ± 25 ppm.

4 Baud rat and connection setting

To change baud rate from 9600 to 19200, and set the connection setting as 8/E/2, the command would be “0x1011”.

Settings	Device ID	Function	Address (High byte)	Address (Low byte)	Data (High byte)	Data (Low byte)	Checksum (High byte)	Checksum (Low byte)
9600	By setting	0x06	0x00	0x02	0x00	-	0xXX	0xXX
19200	By setting	0x06	0x00	0x02	0x10	-	0xXX	0xXX
38400	By setting	0x06	0x00	0x02	0x20	-	0xXX	0xXX
57600	By setting	0x06	0x00	0x02	0x30	-	0xXX	0xXX
115200	By setting	0x06	0x00	0x02	0x40	-	0xXX	0xXX
8/N/1	By setting	0x06	0x00	0x02	-	0x00	0xXX	0xXX
8/N/2	By setting	0x06	0x00	0x02	-	0x01	0xXX	0xXX
8/E/1	By setting	0x06	0x00	0x02	-	0x10	0xXX	0xXX
8/E/2	By setting	0x06	0x00	0x02	-	0x11	0xXX	0xXX
8/O/1	By setting	0x06	0x00	0x02	-	0x20	0xXX	0xXX
8/O/2	By setting	0x06	0x00	0x02	-	0x21	0xXX	0xXX

* Remark: The connection setting format is Word length/Parity/Stop bits; Parity: N = None, E = Even, O = Odd

Reset to default settings

To reset all the settings to default, please press and hold SW2 for 5 sec.

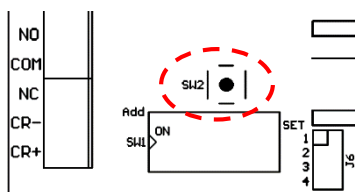

Dimensions (Unit: mm)

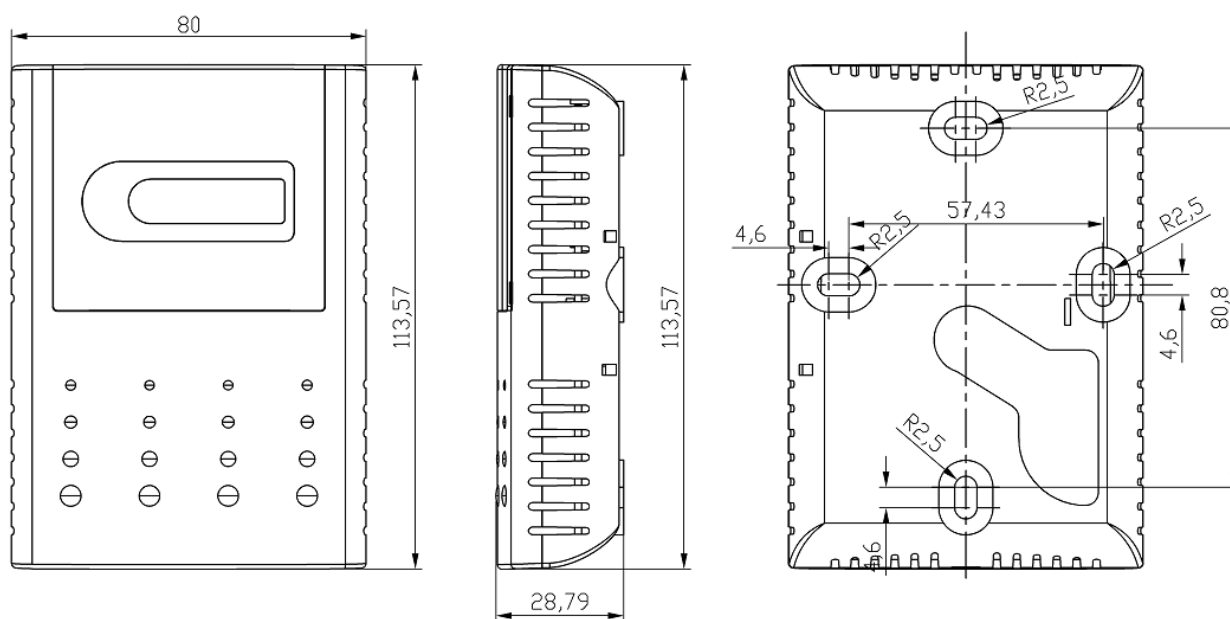

Installation

1. Please check if the transmitter, accessory pack and instruction manual are included in the package.
2. Please decide right position for installation.
****Notice: As carbon monoxide is slightly less dense than air, it is recommended to install the unit around 30cm from ceiling, in order to get faster response.**
3. Press tenon on bottom of the housing with a screw driver to remove the upper cover.
(Please refer to the Figure 2 to Figure 4).



【Figure 2】

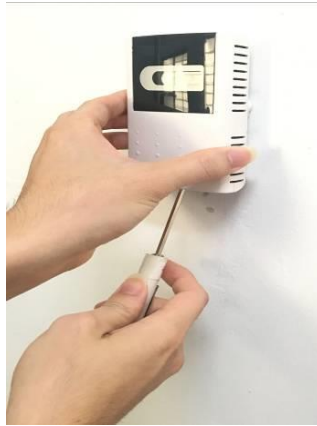

【Figure 3】



【Figure 4】

4. Please refer Figure 1 for wiring.
****Notice: Please remove power from the unit before wiring, in order to avoid any damage or hazard.**
5. Fix the base on the wall and then replace the upper cover.

Notice for installation

1. Please install the transmitter near the ceiling and the height is around eye level.
2. Do not mount the transmitter near doors, opening windows, fans, air outlet or other known air disturbances.
3. Please avoid the waterish area
4. Do not install the transmitter on an unstable or shaking surface.
5. Please do not install the transmitter in areas with rapid temperature changes or with extreme ambient conditions.