

AVC-510 series

AVC-510 transmitter is applied for indoor air quality monitoring and provides monitoring data as reference for improving air quality. It can accurately measure particle matter (PM) and send detail data through RS485, Modbus RTU or LoRa to monitoring center or to HVAC system. The immediate action can be taken, for example, to trigger ventilation system or to activate air purifier to ensure better indoor air quality. Easy installation and perfectly for enclosed space, residential apartment, offices or factories.

■ Features

- High precision sensing element
- RS485, Modbus RTU
- LoRa (Peer to Peer) wireless transmission is available
- High reliability and stability
- Rapid response



■ Dimensions

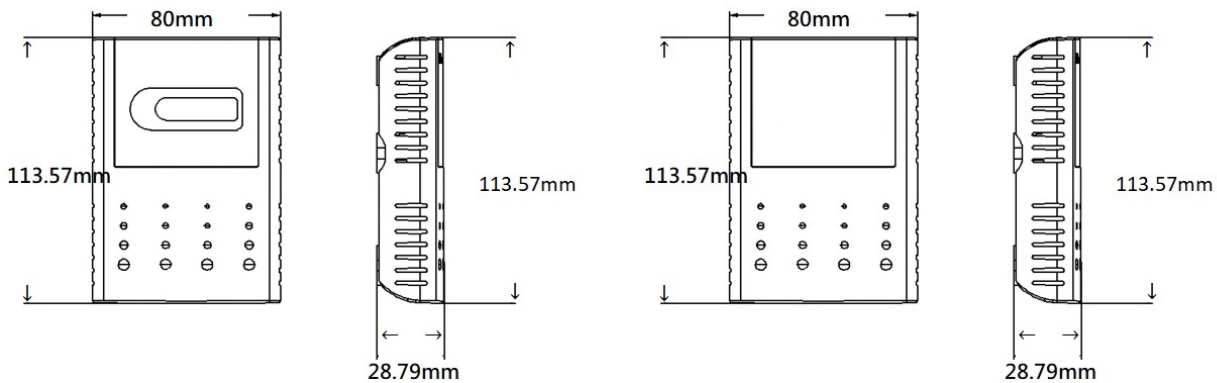

■ Specifications

Model	AVC-510
Measuring principle	Laser scattering method
Response time	≤10 sec.
Counting efficiency	98@≥0.5um
Accuracy (at 25°C)	0 ~ 100µg/m ³ (±10µg/m ³); 100 ~ 600µg/m ³ (±10%)
Resolution	1 µg/m ³
Standard volume	0.1L
Measuring range	0 ~ 600µg/m ³
Coverage area	About 100m ² ⁽¹⁾ ⁽⁴⁾
Signal output	RS485 (Modbus RTU); LoRa (Peer to Peer), radio frequency band: 862 ~ 932 MHz ⁽²⁾
Calibration interval (Recommended)	12 months
Sensor lifespan	3 years ⁽³⁾
Pressure range	1 atm ±10%
Operating environment	-10°C ~ 50°C (14 ~ 122°F); 15 ~ 90%RH (non-condensation)
Storage temperature	-10°C ~ 50°C (14 ~ 122°F)
Warm-up time	≤ 10 Sec.
Power supply	DC 12 ~ 36V, AC 24V (50/60Hz)
Power consumption	RS485: 1.1W (Max.); LoRa / RS485: 2W (Max.)
Housing material	Fireproof ABS
IP rate	IP30 (No protection from liquids)
Certifications	CE and FCC

Note:

- (1) The coverage area should be considered individually to account for the particular layout and any varying or enclosed spaces. It is recommended to install at least one device in each room.
- (2) The frequency channels will be differed by country and this frequency can be configured accordingly from 862 to 932Hz.
- (3) The lifespan of sensor might vary depending on environmental conditions. For example, high ambient temperature will shorten its lifespan.
- (4) The recommended height of installation is 1~2M above the floor level.

■ Ordering information

AVC-510□□□-M

Code 1	Installation	Code 2	Output	Code 3	Display
W	Wall-mount	4	RS-485	X	No
		6	RS-485 / LoRa	D	Yes