

iSMA-B-AAC20



Advanced Application Controller

MODEL	DESCRIPTION
iSMA-B-AAC20	Advanced Application Controller
iSMA-B-AAC20-D	Advanced Application Controller with DALI protocol
iSMA-B-AAC20-M	Advanced Application Controller with M-Bus protocol
iSMA-B-AAC20-LCD	Advanced Application Controller with LCD display
iSMA-B-AAC20-LCD-D	Advanced Application Controller with LCD display and DALI protocol
iSMA-B-AAC20-LCD-M	Advanced Application Controller with LCD display and M-Bus protocol



APPLICATION AND USE

The iSMA-B-AAC20 is an advanced control device to building automation and HVAC systems. Using SVM (Sedona Virtual Machine) allows the user to quickly and easily program in real time. Large number of inputs and outputs allows to integrate with other devices and sensors (AAC20 provides 8 UI, 4 DI, 4/6 AO and 4 DO). Legible, fully programmable LCD, can be used as simple interface to local operation of system. Built-in RS485 can be used to expand number of I/O by connecting MINI or MIX series I/O modules using Modbus RTU/ASCII. In addition, to increase the versatility of the controller, it supports many open communications protocols: BACnet, Modbus, SOX, DALI, M-Bus, 1-Wire or oBIX. The AAC20 is mounted in a housing adapted for DIN rail mounting or directly on a panel. Separate, easy to remove connectors allow quick wiring without removing the entire module.

FEATURES

- Sedona Framework 1.2 support
- Real-time clock (RTC)
- 2 Fast Ethernet with built-in switch
- RS485 port (Modbus or BACnet)
- Built-in LCD display (option)
- Micro SD card slot to log historical data and alarms
- Fast processor with ARM dual core 204 MHz
- Built-in Modbus gateway TCP/IP to RS485
- DALI interface: built-in power supply (option)
- M-Bus interface: up to 20 devices (option)
- 1 Wire interface
- iC Tool – free of charge programming soft
- Configuration via web
- Built-in visualization web server

TECHNICAL CHARACTERISTICS

DESCRIPTION		AAC20
Power supply	Voltage	24 V AC/DC \pm 20%
Universal inputs	Number of inputs	8
	Voltage input	Voltage measurement: 0-10 V DC Input impedance: 100 k Ω Measurement accuracy: \pm 0.1% Measurement resolution: 3 mV at 12-bit and 1 mV at 16-bit
	Current input	Current measurement: 0-20 mA Required external resistor: 200 Ω Measurement accuracy: \pm 1.1% Measurement resolution: 15 μ A at 12-bit and 5 μ A at 16-bit
	Digital input	Output current \sim 1 mA

The performances stated in this sheet can be modified without any prior notice.

DESCRIPTION		AAC20
Universal inputs	Resistance input	Measurement of resistance: 0-1000 kΩ Measurement resolution for 20 kΩ load: 20 Ω at 12-bit and 1 Ω at 16-bit Measurement resolution for PT1000 and NI1000: 0.1 Ω at 16-bit Resistance measurement method: voltage divider
	Temperature input	Measurement with RTDS (Real Time Digital Simulator) attached Accuracy: ±0.1°C The PT1000 and NI1000 sensors use 16-bit resolution
	Measurement resolution	12-bit (default), 16-bit
	Processing time	10 ms/channel at 12-bit 140 ms/channel at 16-bit
Digital inputs	Number of inputs	4
	Type	Dry contact or fast pulse counter
	Maximum input frequency	100 Hz saved in EEPROM memory
Analog outputs	Number of outputs	6
	Voltage range	0-10 V DC
	Maximum load current	20 mA (AO6 up to 5 mA)
	Resolution	12-bit
	Accuracy	±0.5%
Digital outputs	Number of outputs	4
	Resistive load (AC1)	3 A at 230 V AC or 3 A at 30 V DC
	Inductive load (AC3)	75 VA at 230 V AC or 30 W at 30 V DC
COM1	RS485 Interface	Up to 128 devices
		Half-duplex
	Communication protocol	Modbus RTU/ASCII (client)
	Port	RJ12
	Baud rate	2400-115200
	Power supply for external device	30 V DC
COM2	RS485 Interface	Up to 128 devices
		Half-duplex
	Communication protocol	Modbus RTU/ASCII (client/server) BACnet MS/TP (client/server)
	Port	Screw connector
Baud rate	2400-115200	
ETH1	Ethernet interface	2 ports, switch mode
	Baud rate	10/100 Mb/s
USB1	USB 2.0	USB type A
Ingress protection	IP rating	IP 40 for indoor installation
Temperature	Storage	-40°C to +85°C (-40°F to +185°F)
	Operating	-10°C to +50°C (14°F to 122°F)
Humidity	Relative	5 to 95% RH (without condensation)
Screw connectors	Type	Removable screw terminals
	Maximum cable size	2.5 mm ² (18...12 AWG)
Housing	Material	Self-extinguishing plastic (PC/ABS)
	Mounting	DIN (DIN EN 50022 norm)
Dimensions	Width	106.30 mm/4.19 in
	Length	113.60 mm/4.47 in
	Height	62.00 mm/2.44 in

Power Supply

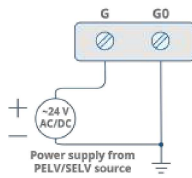

Communication

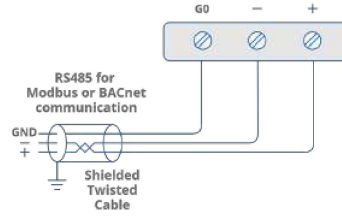

Universal Inputs

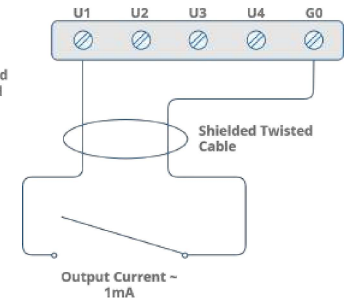
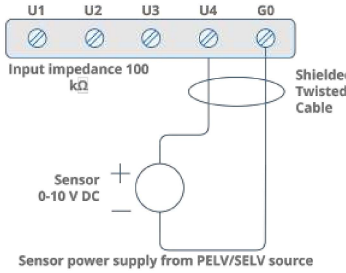
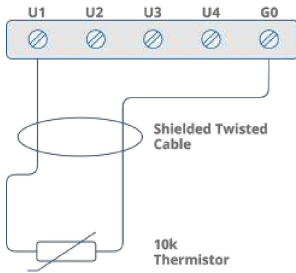
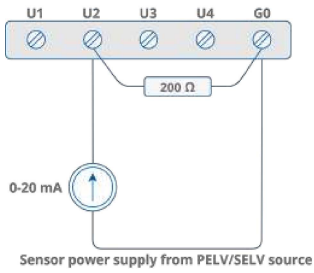

Digital Inputs

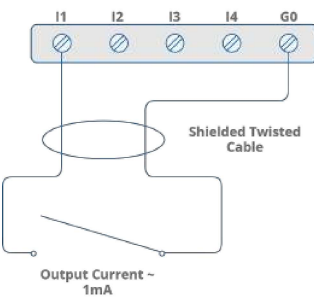

Analog Outputs

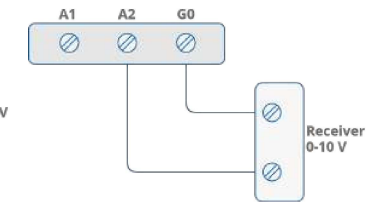
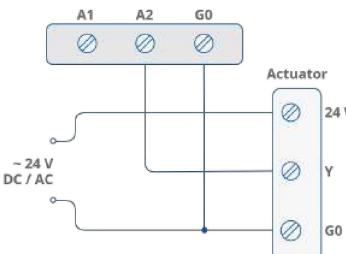
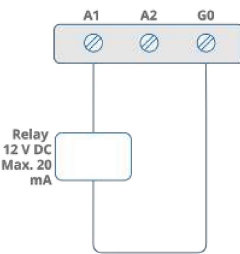

Digital Outputs

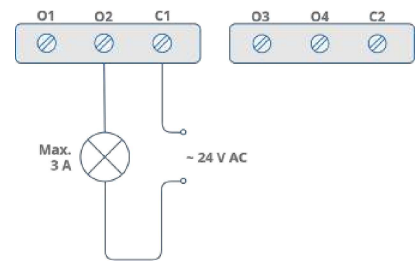
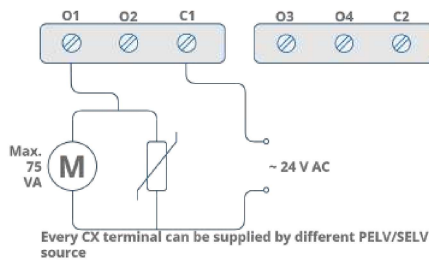
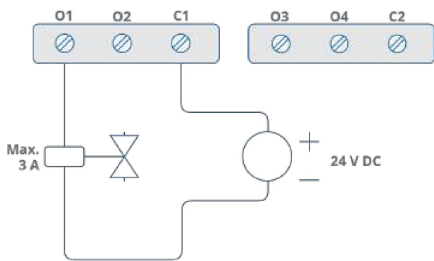

BUILT-IN VISUALIZATION WEB SERVER

The visualization web server allows for displaying the parameters and statuses, setting time schedules, and controlling the unit. Visualization can be fully customized to fit the user needs. The web server is based on HTML5, which enables the visualization to be displayed on our Android panel and any modern Internet browser.

