

MARK II MOLDED PLASTIC MANOMETERS

3% Accuracy For Stationary And Portable Applications

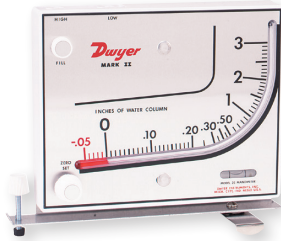

Mark II Model No. 25 inclined-vertical manometer.
(shown with optional A-612 portable stand)

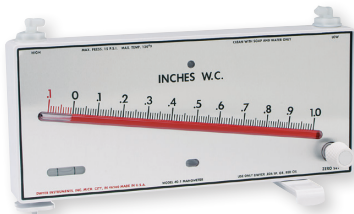
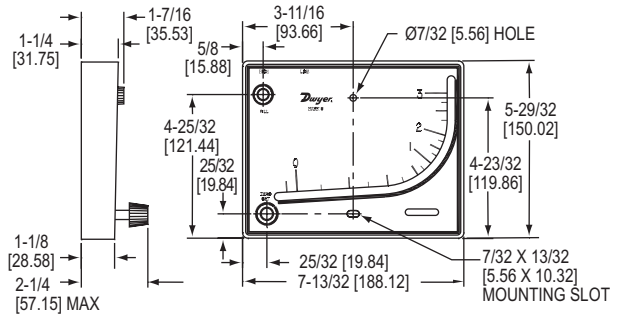

Mark II Model No. 40-1 inclined manometer

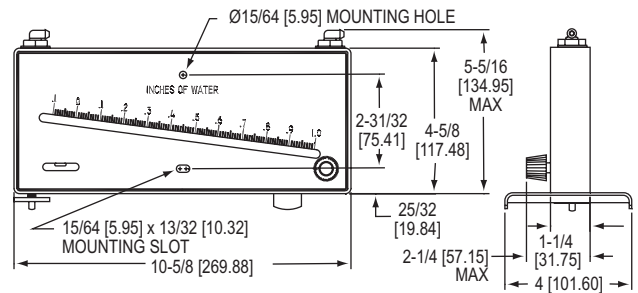

Series Mark II Molded Plastic Manometers are of the inclined and inclined-vertical types. The curved inclined-vertical tube of the Model 25 gage provides higher ranges with more easily read increments at low readings. The Model 25 is excellent for general purpose work. The Model 40 inclined gage provides linear calibration and excellent resolution throughout its range. The Model 40 is ideally suited for air velocity and air filter gage applications. Both gage types are capable of pressure measurements above and below atmospheric as well as differential pressure measurements. Included with each Mark II manometer are two tubing connectors for 1/8" pipe or sheet metal ducts, two mounting screws, 1 ounce bottle of indicating fluid, red and green pointer flags and complete instructions.

The Model 25 also includes 8' of flexible double column plastic tubing. Portable operation of the Model 25 is made possible by the use of the optional A-612 portable stand. A short piece of tubing can be slipped over the Model 25 pressure connections to contain the gage fluid in transit.

The Model 40 contains two 4-1/2' lengths of clear plastic tubing, a plastic swing-out stand and leveling screw for portable operation. It also features convenient rapid shutoff pressure connections and integral overpressure safety traps.

FEATURES/BENEFITS

- Broad ranging in easy to read calibrated increments
- Gages ideally suited for general measurements and specific air applications
- Compact, stationary or portable device, make it a simple to use tool for pressure measurement in OEM or user applications

APPLICATIONS

- Paint booths
- Air velocity measurement
- Air filter gage

OEM SPECIALS

All Dwyer® Mark II molded plastic manometers can be supplied in OEM quantities with your name or special graphics and scales.

ACCESSORIES

Model	Description
A-612	Portable stand
A-606	Air filter kit
A-480	Plastic static pressure tip
A-489	4" straight static pressure tip with flange

SPECIFICATIONS

INCLINED/VERTICAL

Accuracy: ±3% FS.
Temperature Limits: 140°F (60°C).
Pressure Limits: 10 psi (70 kPa).
Weight: 1.04 lb (472 g).
Agency Approvals: Meets the technical requirements of EU Directive 2011/65/EU (RoHS II).

INCLINED

Accuracy: ±3% FS.
Temperature Limits: 150°F (65°C).
Pressure Limits: 15 psi (100 kPa).
Scale Length: Approx. 8-1/4" (21 cm).
Weight: 1.23 lb (558 g).
Agency Approvals: Meets the technical requirements of EU Directive 2011/65/EU (RoHS II).

MODEL CHART

Model	Range	Fluid Used
Mark II 25	0-3 in w.c	Red fluid, .826 s.g.
Mark II 26	0-7 in w.c.	Blue oil, 1.91 s.g.
Mark II 27*	0-7000 fpm	Red fluid, .826 s.g.
Mark II MM-80	0-80 mm w.c.	Red fluid, .826 s.g.
Mark II M-700PA	10-0-700 Pa	Red fluid, .826 s.g.
Mark II 40-1	.1-0-1.0 in w.c.	Red fluid, .826 s.g.
Mark II 40-25MM	0-26 mm w.c.	Red fluid, .826 s.g.
Mark II 40-250PA	10-0-250 Pa	Red fluid, .826 s.g.
Mark II 41-60MM	0-60 mm w.c.	Blue oil, 1.91 s.g.
Mark II 41-600PA	20-0-600 Pa	Blue oil, 1.91 s.g.

*Require Pitot tube at additional cost. ①

① Pitot tube: See pages 186-188 (Test & Data section)

Process Tubing Options: See page 455 (Gage Tubing Accessories)