

## Balancing Valves

## V4-BLC-GP16

### FLANGED BALANCING AND SHUT-OFF VALVES

#### PRODUCT SPECIFICATION SHEET



### CONTENTS

- Design.....1
- Materials.....1
- Application.....1
- Features.....1
- Specifications.....2
- Dimensions and ordering information.....2
- Flow diagrams V4 Kombi-F.....3 to 11
- Influence of coolants on flow values.....12
  - Correction factor f.....12

### Application

The hydronic balance is a significant requirement for the efficient operation of a hydronic heating or cooling installation. In an unbalanced system under or over provision of hot water to individual radiators or circuits can occur. Apart from the correct selection of radiator valves, regulation of individual circuits is also necessary and in some cases, such as DIN 18 380, VOB part C, is required by national standards. This requirement is met with V4 Kombi shutoff and balancing valves. V4 Kombi have functions shut-off, pre-setting and measuring.

### Features

- **Balancing through stroke limitation with digital pre-setting and visible pre-setting indicator**
- **Equipped with 2 pressure test cocks for differential pressure measurement**
- **Non rising spindle with EPDM and EPDM O-ring sealing**
- **Pre-setting isn't altered when handwheel is turned**
- **Regulation screw protected by protection cap**
- **PTFE seat sealing**
- **Valve cartridge and spindle made of cast steel**
- **Available in dimensions up to DN400**

### Design

- Valve body with flanges drilled to DIN
- Valve insert with handwheel and pre-setting display
- Pressure test cocks

### Materials

Part	Material	Standard
1. Body	Cast Iron	EN-JL1040
2. Bonnet	Cast Iron	EN-JL1040
3. Insert	Carbon Steel, chromium plated with PTFE seat ring	CLA <sub>1</sub> Gr. B
4. Gasket	Graphite	304S15+
5. Stem	Stainless Steel	420S37
6. Handwheel	Ductile Iron	EN-JS1050

## Specifications

<b>Flange</b>	BS4504 PN16 or ANSI B16.1 Class 125. Other flange types are available.
<b>Operating temperature</b>	-10 to 120 °C (14 to 248 °F)
<b>Nominal pressure</b>	16 Bar or 125 Psi
<b>kvs-values</b>	see table below and flow

## Dimensions and ordering information

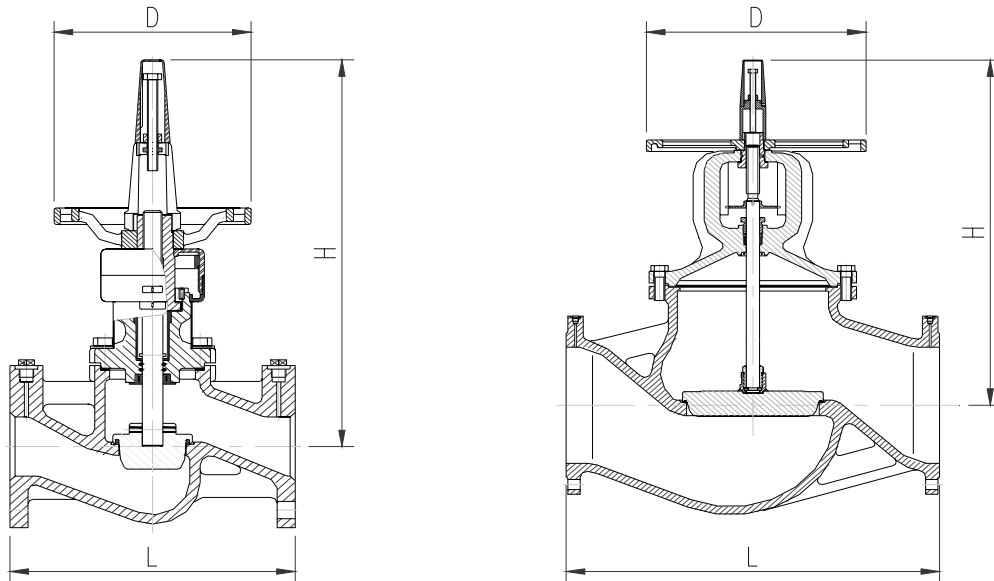

DN	(R)	kvs-value	L	H	Ø D	n x Ø d	OS-No.
65	2 1/2"	74,4	290	420	190	4 x 19	V4-BLC-GP16-G065
80	3"	111	310	443	190	8 x 19	V4-BLC-GP16-G080
100	4"	165	350	477	190	8 x 19	V4-BLC-GP16-G100
125	5"	236	400	511	305	8 x 19	V4-BLC-GP16-G125
150	6"	365	480	550	305	8 x 23	V4-BLC-GP16-G150
200	8"	704	600	665	305	8 x 23	V4-BLC-GP16-G200

DN	(R)	kvs-value	L	H	Ø D	n x Ø d	OS-No.
250	10"	945	730	829	515	12 x 28	V4-BLC-GP16-G250
300	12"	1.635	850	883	515	12 x 28	V4-BLC-GP16-G300
350	14"	2.220	980	1088	715	16 x 28	V4-BLC-GP16-G350

**NOTE: All dimensions in mm unless otherwise stated**

## Flow diagram V4 Kombi-F, DN 65

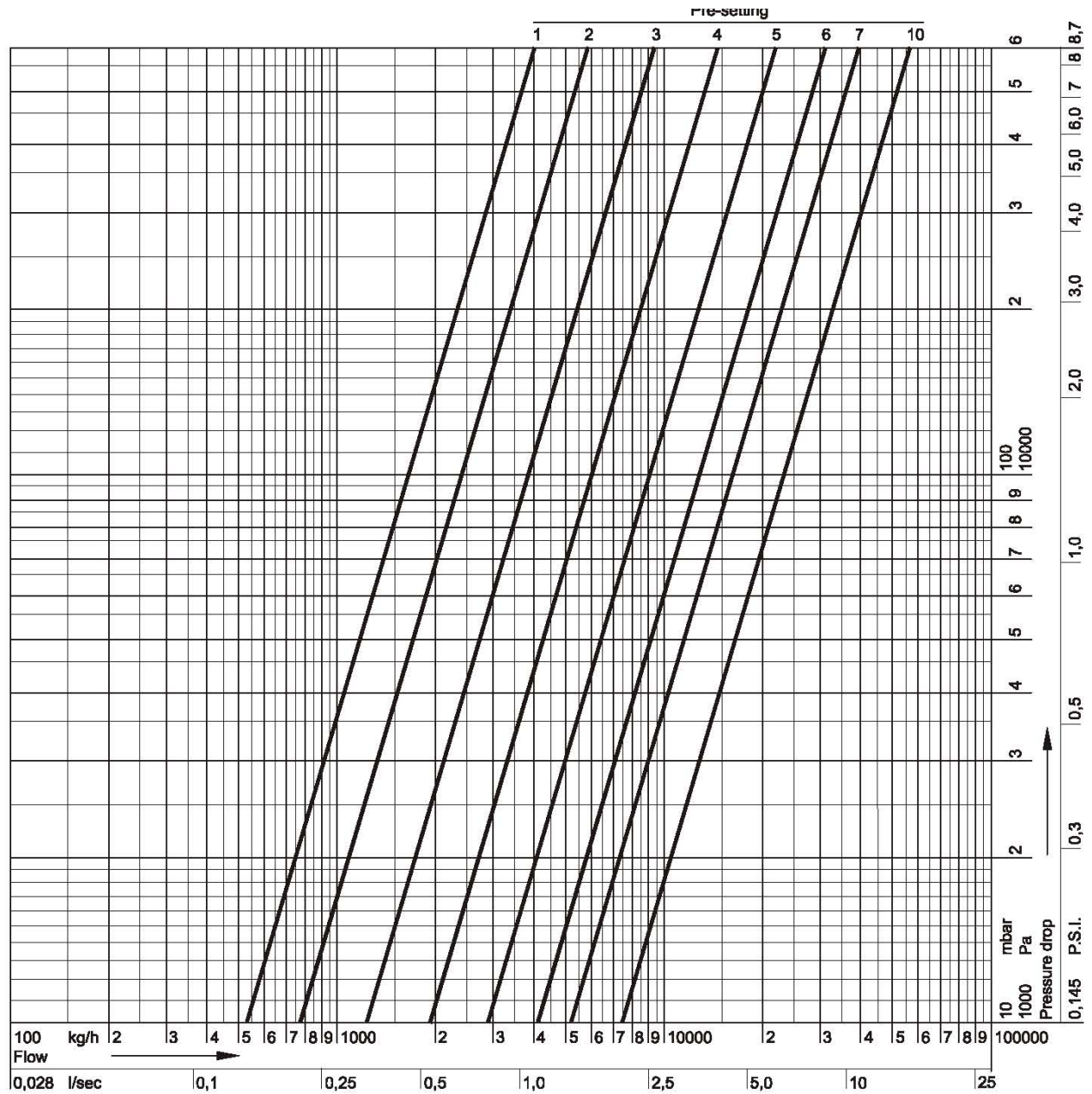

<b>Pre-setting</b>	0,5	1,0	1,5	2,0	2,5	3,0	3,5	4,0	4,5	5,0	5,5	6,0	6,5	7,0	8,0
<b>k<sub>v</sub>-value</b>	2,98	5,30	6,64	7,80	9,60	12,1	15,2	19,0	23,6	29,1	35,2	41,3	47,0	52,1	60,7

<b>Pre-setting</b>	9,0	10,0 = open
<b>k<sub>v</sub>-value</b>	67,9	k <sub>vs</sub> = 74,4

## Flow diagram V4 Kombi-F, DN 80

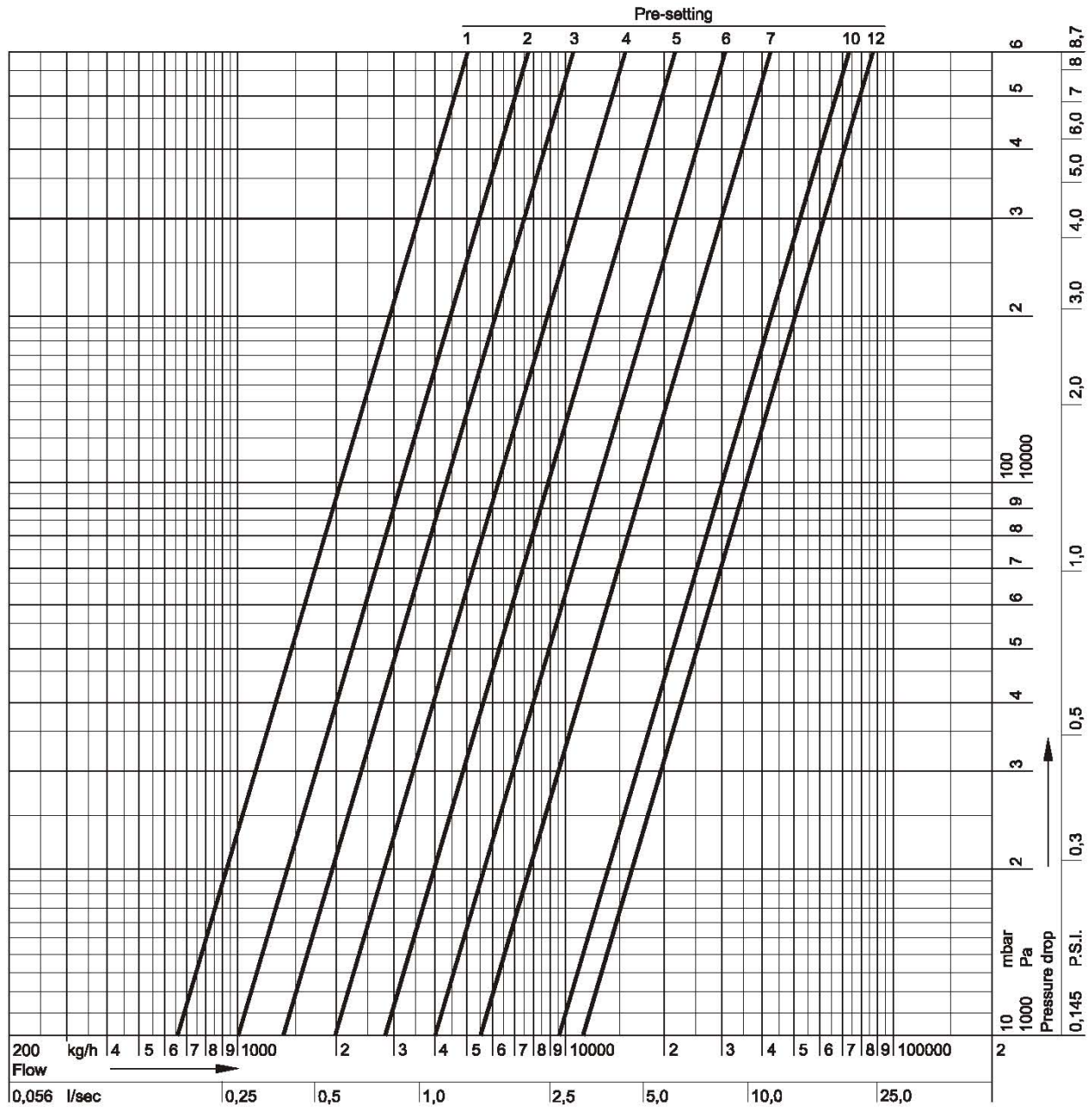

Pre-setting	0,5	1,0	1,5	2,0	2,5	3,0	3,5	4,0	4,5	5,0	6,0	7,0	8,0	9,0	10,0
kv-value	3,65	6,60	8,52	10,0	11,7	13,7	16,1	19,2	23,2	28,1	40,4	55,4	70,9	84,8	96,1

Pre-setting	11,0	12,0 = open
kv-value	104	kvs = 111

## Flow diagram V4 Kombi-F, DN 100

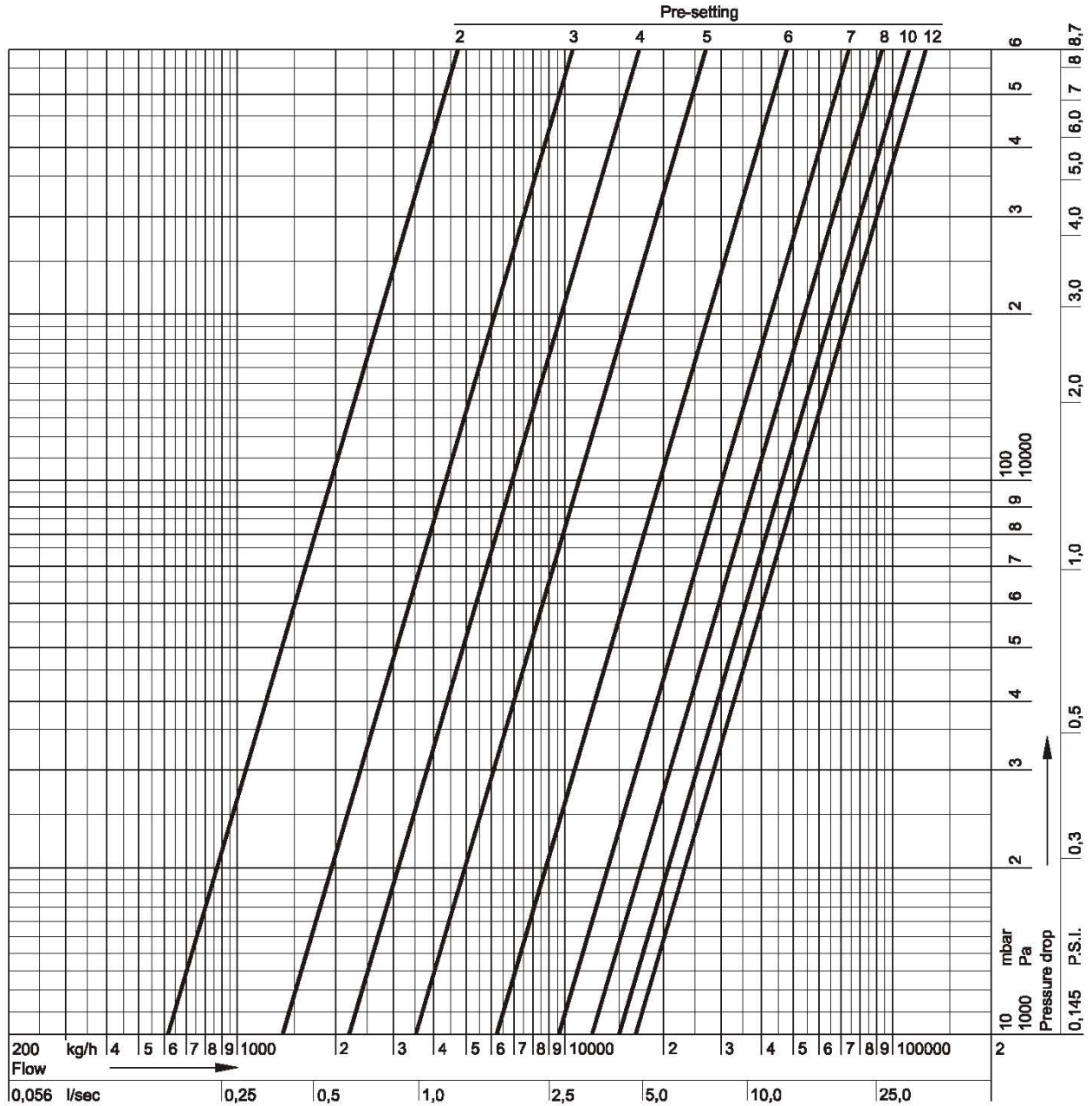

Pre-setting	1,5	2,0	2,5	3,0	3,5	4,0	4,5	5,0	5,5	6,0	6,5	7,0	7,5	8,0	9,0
k <sub>v</sub> -value	3,80	6,20	9,60	13,4	17,3	21,8	27,6	35,7	47,2	62,4	79,3	96,6	110	121	137

Pre-setting	10,0	11,0	12,0 = open
k <sub>v</sub> -value	148	157	k <sub>vS</sub> = 165

## Flow diagram V4 Kombi-F, DN 125

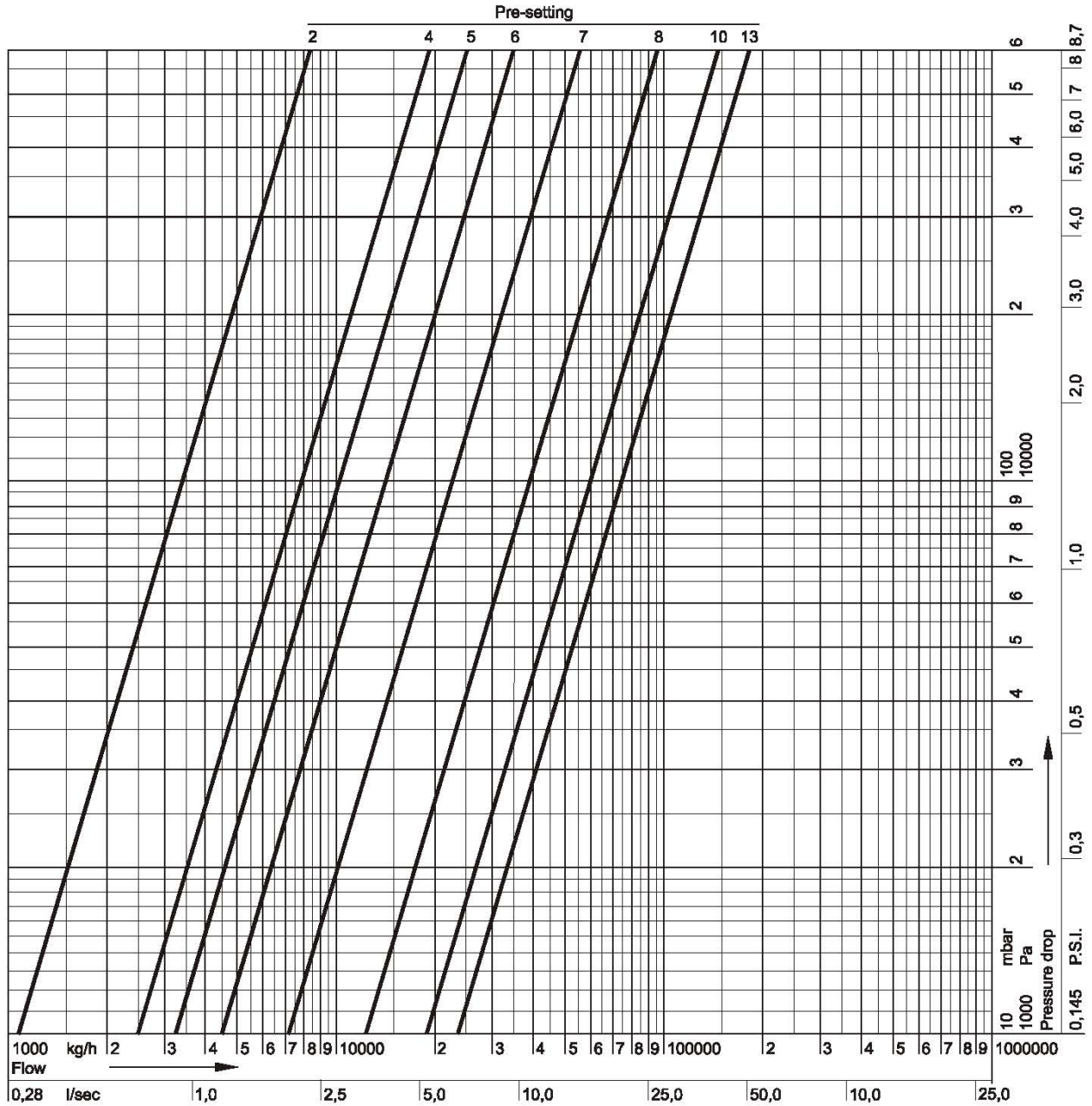

<b>Pre-setting</b>	1,5	2,0	2,5	3,0	3,5	4,0	4,5	5,0	5,5	6,0	6,5	7,0	7,5	8,0	9,0
<b>kv-value</b>	8,30	11,3	14,4	17,7	21,1	24,6	28,2	32,3	37,4	44,9	56,1	72,5	93,2	120	162

<b>Pre-setting</b>	10,0	11,0	12,0	13,0 = open
<b>kv-value</b>	192	211	225	$k_{vs} = 236$

## Flow diagram V4 Kombi-F, DN 150

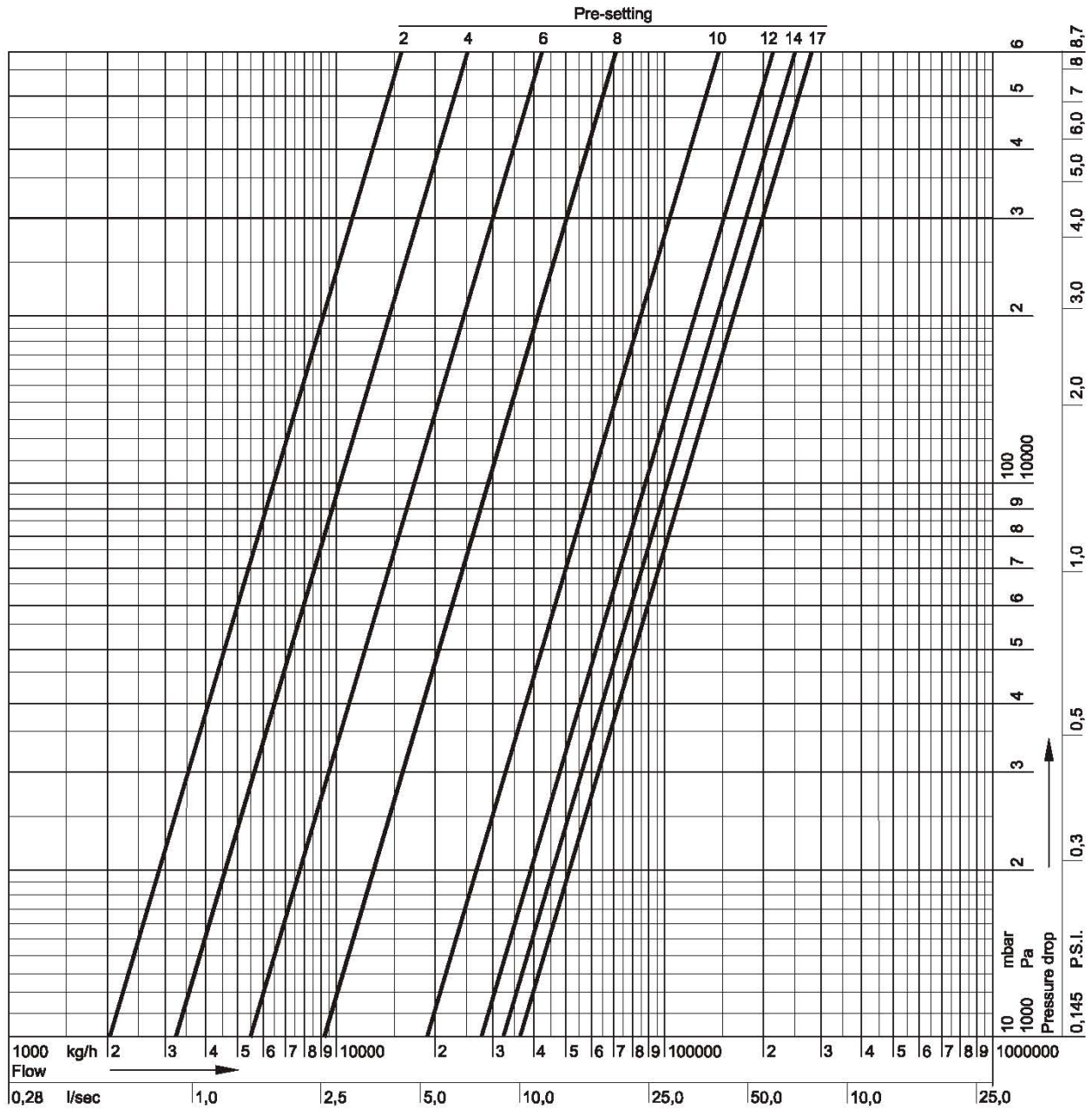

Pre-setting	1,5	2,0	2,5	3,0	3,5	4,0	4,5	5,0	5,5	6,0	6,5	7,0	7,5	8,0	9,0
k <sub>v</sub> -value	16,2	20,4	23,8	26,7	29,5	33,0	37,6	42,3	48,0	54,5	61,5	69,6	80,0	92,9	136

Pre-setting	10,0	11,0	12,0	13,0	14,0	15,0	16,0	17,0 = open
k <sub>v</sub> -value	193	240	274	300	320	337	352	k <sub>vS</sub> = 365

## Flow diagram V4 Kombi-F, DN 200

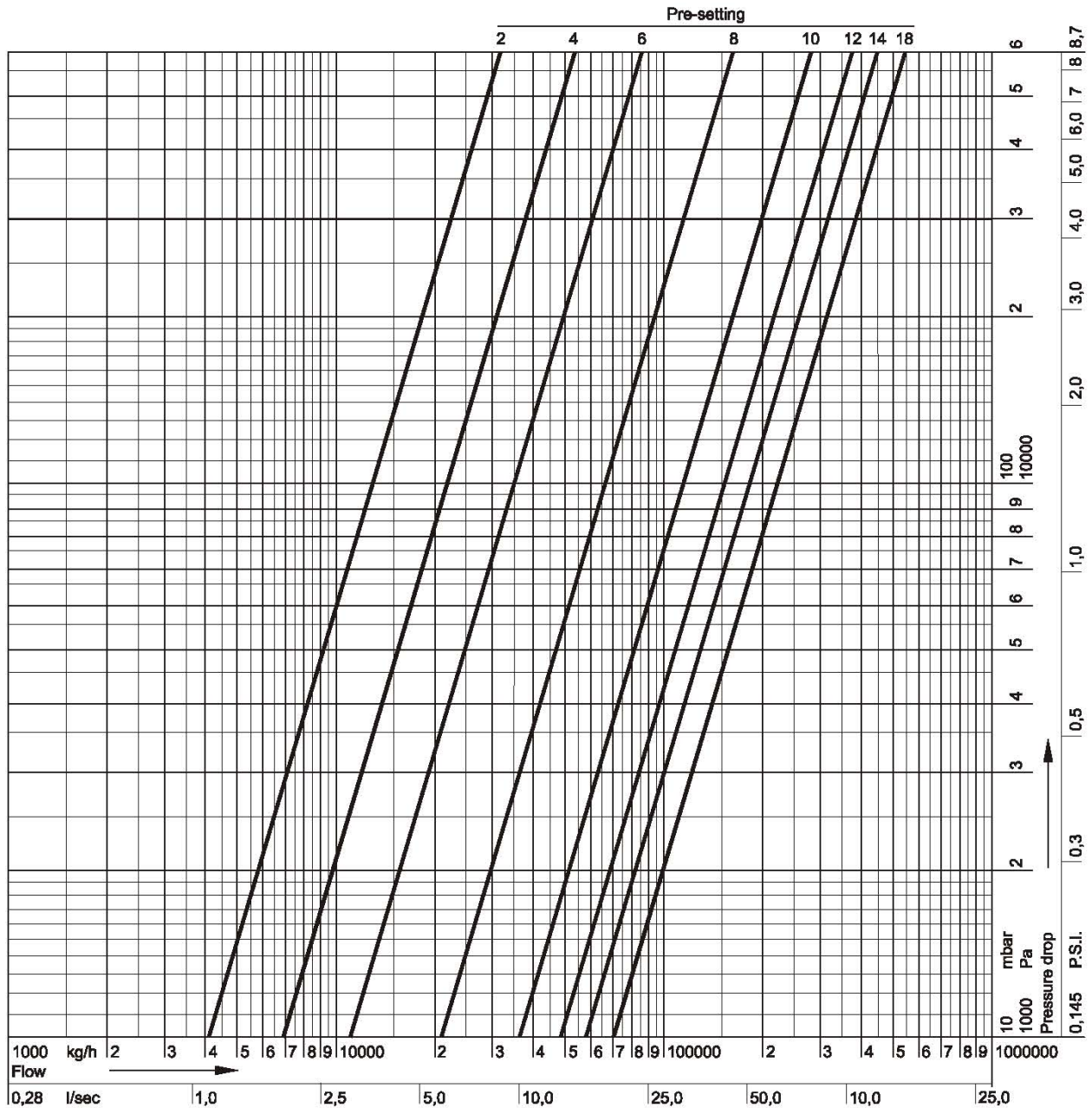

<b>Pre-setting</b>	1,5	2,0	2,5	3,0	3,5	4,0	4,5	5,0	5,5	6,0	6,5	7,0	7,5	8,0	9,0
<b>kv-value</b>	32,5	41,3	48,9	55,5	62,1	69,3	77,8	88,1	101	115	133	154	179	208	284

<b>Pre-setting</b>	10,0	11,0	12,0	13,0	14,0	15,0	16,0	17,0	18,0 = open
<b>kv-value</b>	364	435	489	537	575	613	646	677	$k_{vs} = 704$

## Flow diagram V4 Kombi-F, DN 250

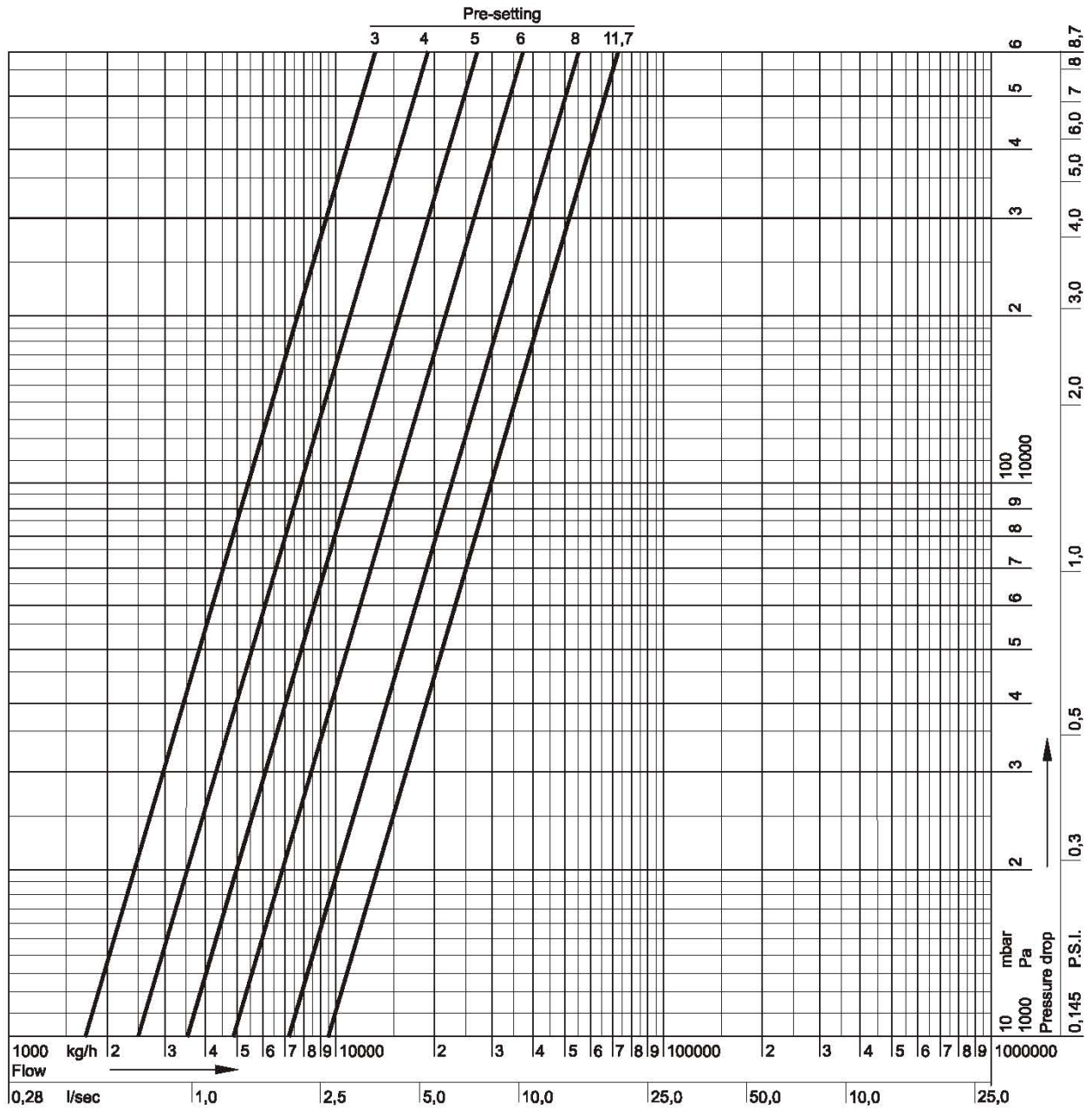

Pre-setting	3	4	5	6	8	11,7 = open
k <sub>v</sub> -value	170	250	356	488	722	k <sub>vs</sub> = 945

## Flow diagram V4 Kombi-F, DN 300

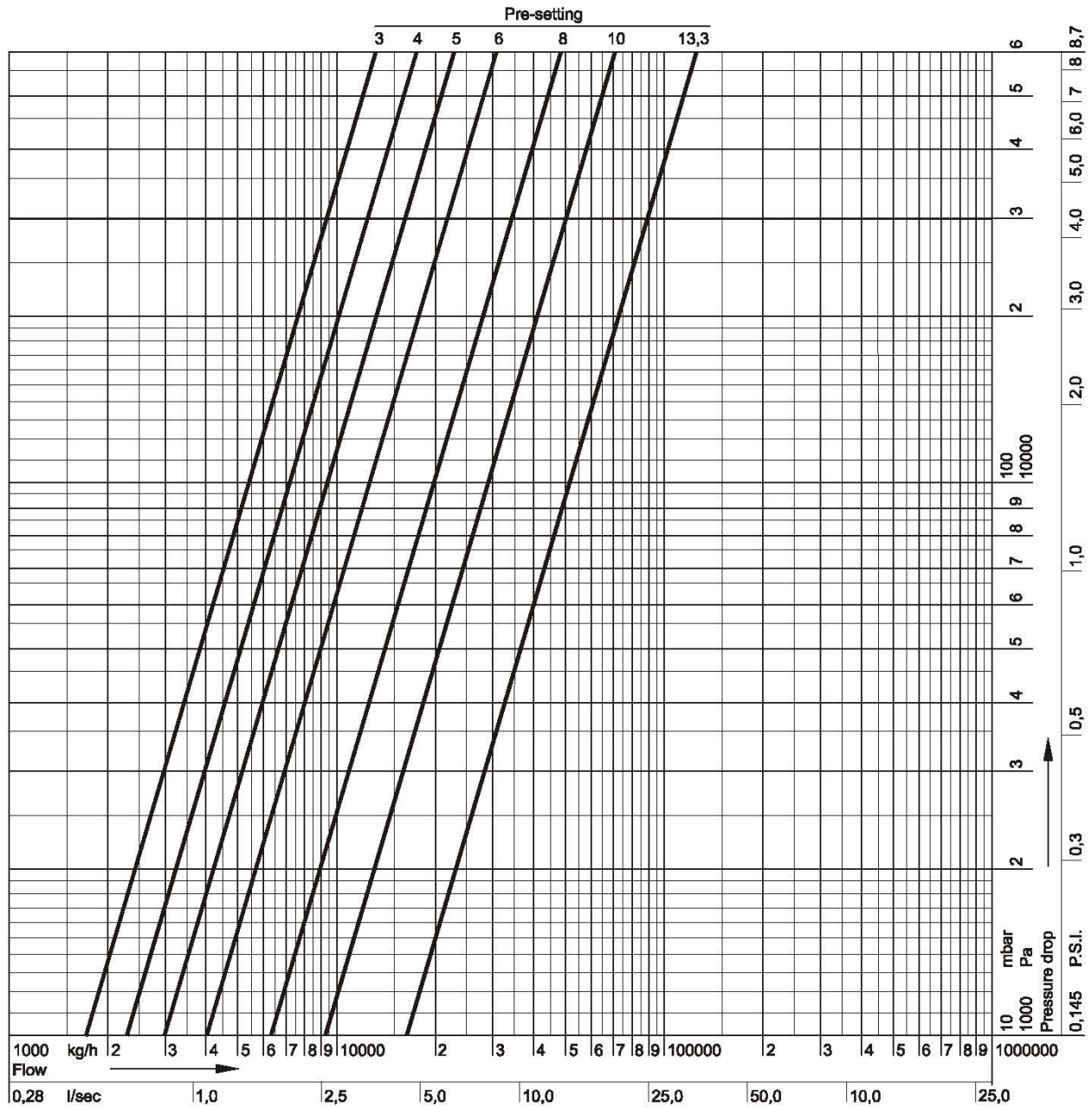

Pre-setting	3	4	5	6	8	10	13,3 = open
k <sub>v</sub> -value	170	230	300	400	630	930	k <sub>vs</sub> = 1.635

## Flow diagram V4 Kombi-F, DN 350

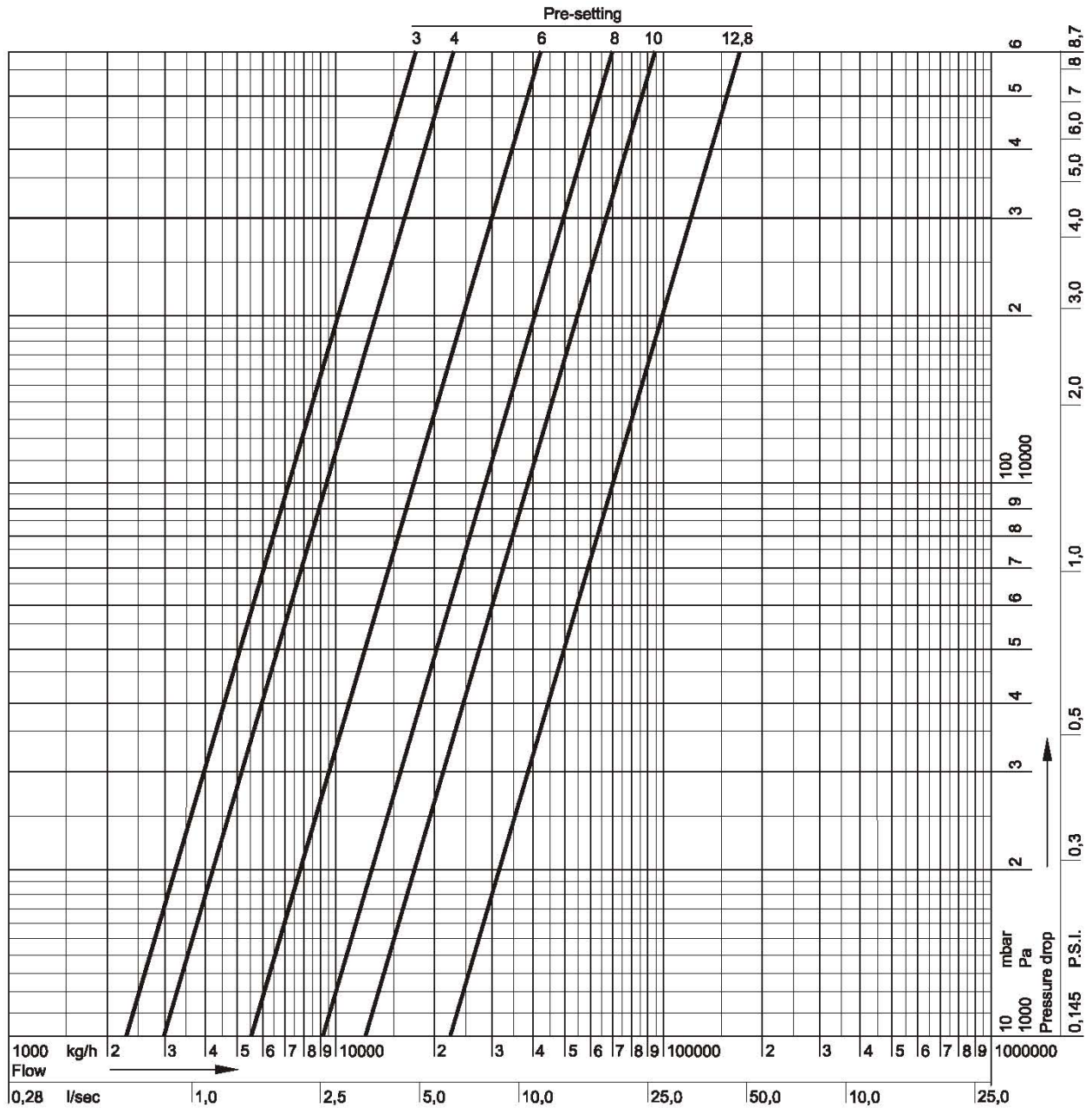

Pre-setting	3	4	6	8	10	12,8 = open
k <sub>v</sub> -value	220	300	550	810	1.320	k <sub>v/s</sub> = 2.220

## Influence of coolants on flow values

The flow through a valve is defined by the kv-value. The kv-value is the flow  $m$  through a valve in [m<sup>3</sup>/h] at a differential pressure of 1 bar (14,5 P.S.I.) and is only valid for fluids with a density of  $\sigma_0 = 1000 \text{ kg/m}^3$ . This condition is met by water at a temperature of 20°C (68°F). For fluids with another density the following formula can be applied:

$$Kv_{Medium} = \frac{m}{\sqrt{\Delta p}} \times \frac{\sqrt{\rho_{Medium}}}{\sqrt{\rho_0}}$$

## Correction factor f

When the density  $\sigma$  is expressed in t/m<sup>3</sup> instead of kg/m<sup>3</sup> the correction factor  $f$  is the result. The correction factor  $f$  can be used to re-calculate kv-value, pressure drop and flow:

$$Kv_{Medium} = Kv_0 \times \frac{1}{\sqrt{f}} \quad \Delta p_{Medium} = \Delta p_0 \times f \quad m_{Medium} = m_0 \times \frac{1}{\sqrt{f}}$$

**Table 1. Values for correction factor f**

Medium	water part	Correction factor f					
		5°C (41°F)	20°C (68°F)	35°C (95°F)	50°C (122°F)	65°C (149°F)	80°C (176°F)
Normal water	100%	1,000	0,998	0,994	0,988	0,981	0,972
Ethylen glycol	70%	1,052	1,047	1,041	1,033	10,24	1,015
e.g. Antifrogen N	50%	1,086	1,079	1,070	1,061	1,052	1,042
Propylen glycol	70%	1,035	1,029	1,021	1,012	1,002	0,991
e.g. Antifrogen L	50%	1,053	1,044	1,035	1,025	1,014	1,002